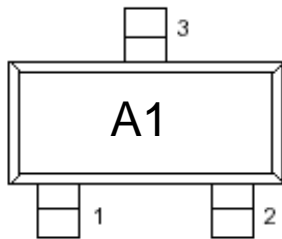
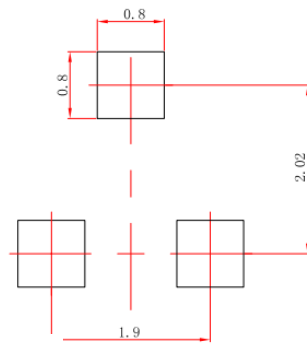
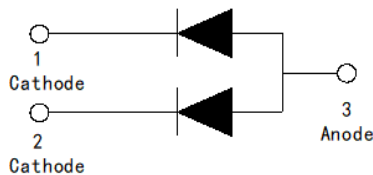
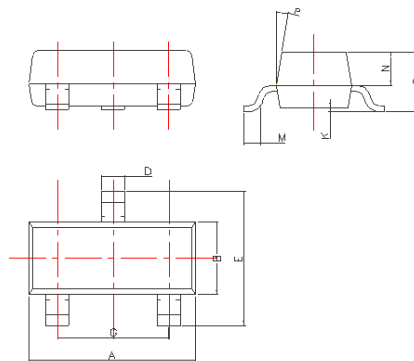

**Kingtronics**®**CDD56-ME****Diode****Marking:A1**

Top view

**Suggested Layout****(±0.05mm)****SOT-23****Dimension**

DIM	Millimeters
A	2.85~3.04
B	1.30±0.10
C	1.00±0.10
D	0.45±0.05
E	2.25~2.55
G	1.90±0.1
K	0.00-0.10
M	0.20 min
N	0.60±0.10
P	7±2°

**MAXIMUM RATINGS (Ta=25°C)**

Characteristic	Symbol	Rating	Unit
Continuous Reverse Voltage	$V_R$	70	Vdc
Peak Forward Current	$I_F$	200	mAdc
Peak Forward Surge Current	$I_{FM(surge)}$	500	mAdc

**THERMAL CHARACTERISTICS**

Characteristic	Symbol	Max	Unit
Total Device Dissipation FR-5 Board(1) TA=25°C	$P_D$	225	mW
Total Device Dissipation Alumina Substrate,(2) TA=25°C	$P_D$	300	mW
Junction and Storage Temperature	$T_J$ , $T_{stg}$	150 , -55 ~150	°C

- FR-5=1.0×0.75×0.062in, printed-circuit board.
- Alumina=0.4×0.3×0.024in, 99.5%alumina

**ELECTRICAL CHARACTERISTICS (TA=25°C unless otherwise noted)**

Characteristic	Symbol	Test Condition	Min	Type	Max	Unit
Reverse Voltage Leakage Current	$I_R$	$V_R=70Vdc$	--	--	2.5	μA
		$V_R=70Vdc, T_j=150°C$	--	--	50	
		$V_R=25Vdc, T_j=150°C$	--	--	30	
Reverse Breakdown Voltage	$V_{(BR)}$	$I_{BR}=100 \mu A$	70	--	--	Vdc
Forward Voltage	$V_F$	$I_F=1mAdc$	--	--	715	mV
		$I_F=10mAdc$	--	--	855	
		$I_F=50mAdc$	--	--	1000	
		$I_F=150mAdc$	--	--	1250	
Diode Capacitance	$C_D$	$V_R=0, f=1.0MHz$	--	--	1.5	pF
Forward Recovery Voltage	$V_{FR}$	$I_F=10mAdc, t_r=20ns$	--	--	1.75	Vdc
Reverse Recovery Time	$t_{rr}$	$I_F=I_R=10mAdc,$ $R_L=100\Omega$	--	--	6.0	nS

**Kingtronics**® International Company

# Kingtronics®

# CDD56-ME

## Typical Performance Characteristics

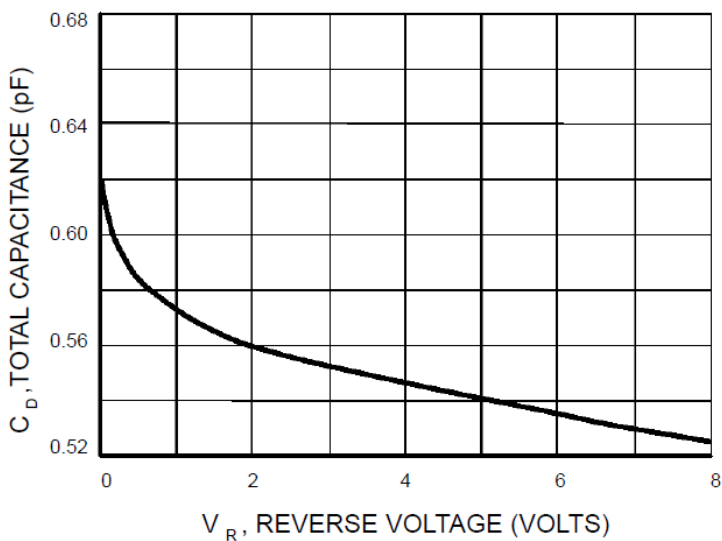
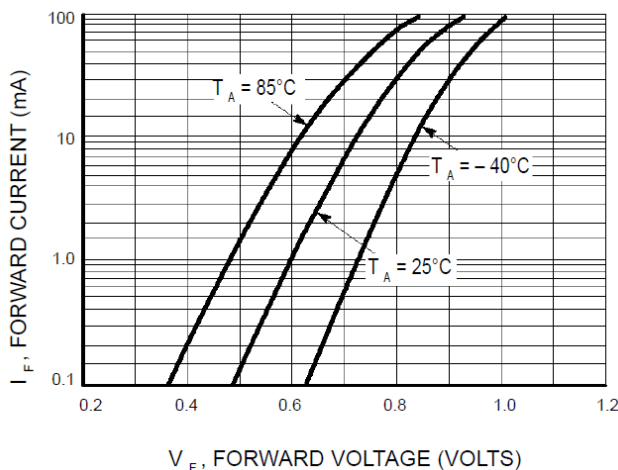
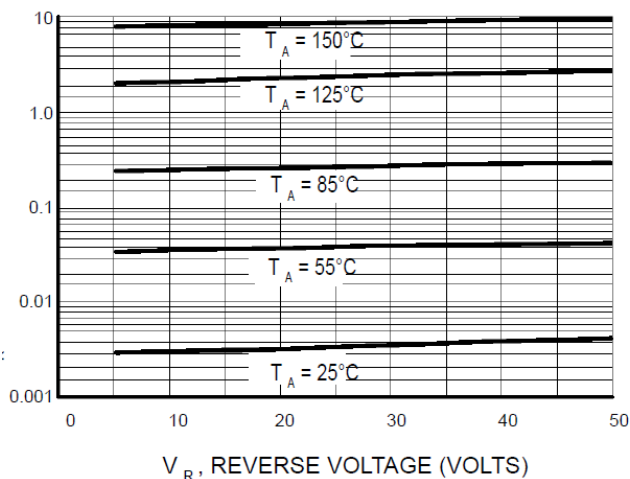

Note: Specifications are subject to change without notice.

**Kingtronics® International Company**

Website: [www.kingtronics.com](http://www.kingtronics.com) Email: [info@kingtronics.com](mailto:info@kingtronics.com) Tel: (852) 8106 7033 Fax: (852) 8106 7099