

Kingtronics®

RKT-3386

Trimming Potentiometers

FEATURES

Single Turn/ Cermet/ Industrial/ Sealed
Many Terminal Styles

PICTURE



Electrical Characteristics

Standard Resistance Range	10Ω - 5MΩ
Resistance Tolerance	±10% ; ±20% for 10, 20 and 2M ohm
Absolute Minimum Resistance	≤±1%R or 10Ω
Contact Resistance Variation	CRV≤±3%R or 5Ω (whichever is larger)
Insulation Resistance	R1≥1GΩ(500Vdc)
Withstand Voltage	640VAC
Effective Travel	260°

Environmental Characteristics

Power Rating (300volts max)	0.5W@70°C, 0W@125°C
Temperature Range	-55°C ~ +125°C
Temperature Coefficient	±200x10 ⁻⁶ /°C (±100ppm/°C on request)
Temperature Variation	-55°C,30min,+125°C/30min, 5 cycles ΔR≤±2%R,Δ(Uab/Uac)≤±2%R
Collision	390m/s ² ,4000cycles,ΔR≤±1%R
Electrical Endurance at 70°C	0.5W@70°C, 1000h ΔR≤±(5%R+0.1Ω), CRV≤±3%R or 5Ω (whichever is larger)
Rotational Life	200 cycles ΔR≤±(10%R+0.5Ω), CRV≤±3%R or 5Ω (whichever is larger)

Physical Characteristics

Starting Torque	≤35mN·m
Marking	Resistance Tolerance (When no identification, it is of ±10%) Resistance Code, Model
Standard Packaging	50pcs, per tube

Common Dimensions

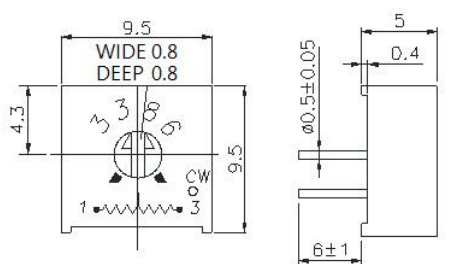

RKT-3386P

RKT-3386F

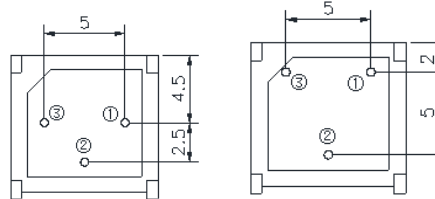

RKT-3386Y

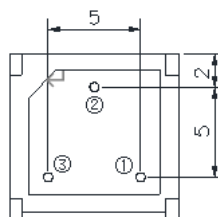

RKT-3386H

RKT-3386X

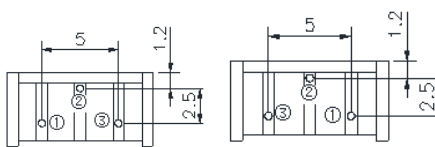

RKT-3386W

RKT-3386C

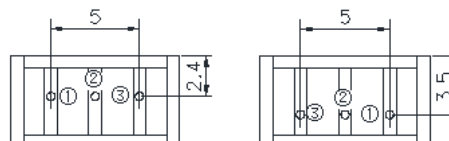

Kingtronics® International Company

How to Order

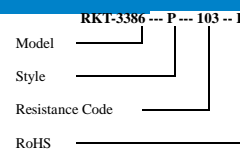

Resistance Table

Resistance (Ohms)	Resistance Code
10	100
20	200
50	500
100	101
150	151
200	201
250	251
300	301
470	471
500	501
680	681
1,000	102
1,500	152
2,000	202
2,200	222
2,500	252
3,000	302
4,700	472
5,000	502
6,800	682
10,000	103
15,000	153
20,000	203
22,000	223
25,000	253
30,000	303
33,000	333
47,000	473
50,000	503
68,000	683
100,000	104
150,000	154
200,000	204
220,000	224
250,000	254
300,000	304
330,000	334
470,000	474
500,000	504
680,000	684
1,000,000	105
2,000,000	205
2,200,000	225
5,000,000	505

Special resistances available.

Kingtronics®

RKT-3386

Trimming Potentiometers

RKT-3386

(STYLE) -EY5-(RESISTANCE CODE)

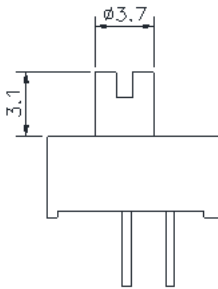

RKT-3386

(STYLE)-EY5-(RESISTANCE CODE)-T

The Model 3386 is available with a knob for finger adjustment. Add suffix letter "T" to order code.

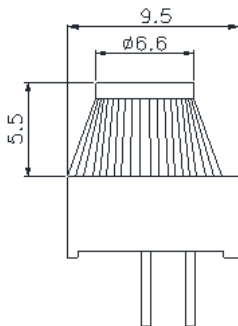

RKT-3386F,K,P,R,U,Y-EY5 (RESISTANCE CODE)-L

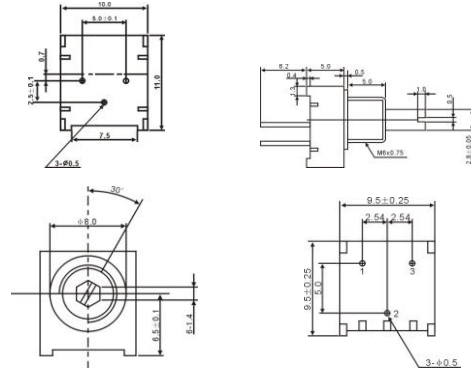

RKT-3386F,K,P,R,U,Y-EY5 (RESISTANCE CODE)-TL

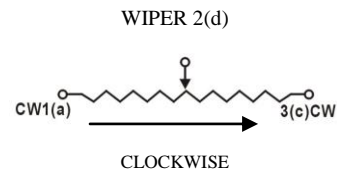
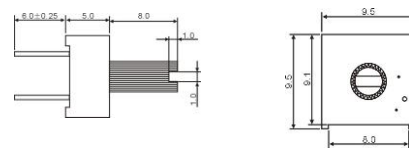

Tolerance is ± 0.25 if no identification

Note: Specifications are subject to change without notice.

Kingtronics® International Company

Website: www.kingtronics.com

Email: info@kingtronics.com

Tel: (852) 8106 7033

Fax: (852) 8106 7099