

SWITCHING TRANSISTOR

Marking: 2F

Suggested Layout

SOT-23

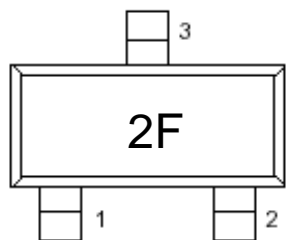

Top view

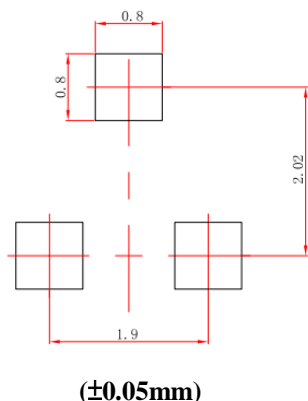
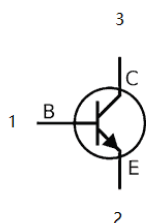

Dimension

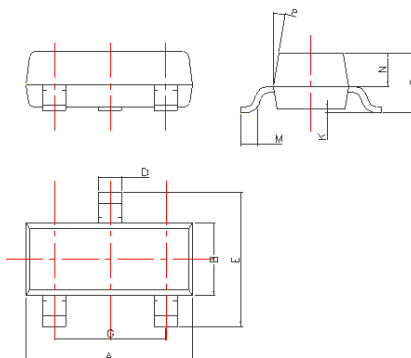

DIM	Millimeters
A	2.85~3.04
B	1.30±0.10
C	1.00±0.10
D	0.45±0.05
E	2.25~2.55
G	1.90±0.1
K	0.00-0.10
M	0.20 min
N	0.60±0.10
P	7±2°

MAXIMUM RATINGS (Ta=25°C)

Characteristic	Symbol	Rating	Unit
Collector-Emitter Voltage	V_{CEO}	-60	Vdc
Collector-Base Voltage	V_{CBO}	-65	Vdc
Emitter-Base Voltage	V_{EBO}	-5	Vdc
Collector Current - Continuous	I_C	-600	mAdc

THERMAL CHARACTERISTICS

Characteristic	Symbol	Max	Unit
Total Device Dissipation FR-5 Board (1) (Ta=25°C)	P_D	225	mW
Derate above 25°C		1.8	mW/°C
Thermal Resistance Junction to Ambient	R_{JA}	556	°C/W
Total Device Dissipation Alumina Substrate, (2) Ta=25°C	P_D	300	mW
Derate above 25°C		2.4	mW/°C
Thermal Resistance Junction to Ambient	R_{JA}	417	°C/W
Junction and Storage Temperature	$T_J,$ T_{stg}	150, -55~150	°C

Kingtronics®**CDS2907A-ME****ELECTRICAL CHARACTERISTICS (TA=25°C unless otherwise noted)**

Characteristic	Symbol	Test Condition	Min	Type	Max	Unit
Collector Cutoff Current	I _{CBO}	V _{CB} =-50Vdc	--	--	-0.01	μAdc
		V _{CB} =-50Vdc, I _E =0, T _A =125°C	--	--	-10	
Collector Cutoff Current	I _{CEX}	V _{CE} =-30Vdc, I _{EB} =-0.5Vdc	--	--	-50	μAdc
Collector-Emitter Breakdown Voltage (3)	V _{(BR)CEO}	I _C =-10mAdc, I _B =0	-60	--	--	Vdc
Collector-Base Breakdown Voltage	V _{(BR)CBO}	I _C =-10 μ Adc, I _E =0	-60	--	--	Vdc
Emitter-Base Breakdown Voltage	V _{(BR)EBO}	I _E =-10 μ Adc, I _C =0	-5.0	--	--	Vdc
DC Current Gain	h _{FE}	I _C =-0.1mAdc, V _{CE} =-10Vdc	75	--	--	--
		I _C =-1mAdc, V _{CE} =-10Vdc	100	--	--	
		I _C =-10mAdc, V _{CE} =-10Vdc	100	--	--	
		I _C =-150mAdc, V _{CE} =-10Vdc	100	--	300	
		I _C =-500mAdc, V _{CE} =-10Vdc	50	--	--	
Collector-Emitter Saturation Voltage (3)	V _{CE(sat)}	I _C =-150mAdc, I _B =-15mAdc	--	--	-0.4	Vdc
		I _C =-500mAdc, I _B =-50mAdc	--	--	-2.6	
Base-Emitter Saturation Voltage	V _{BE(sat)}	I _C =-150mAdc, I _B =-15mAdc	--	--	-1.3	Vdc
		I _C =-500mAdc, I _B =-50mAdc	--	--	-2.6	
Current-Gain-Bandwidth Product	f _T	I _C =-50mAdc, V _{CE} =-20Vdc, f=100MHz	200	--	--	MHz
Output Capacitance	C _{obo}	V _{CB} =-10Vdc, I _E =0, f=1.0MHz	--	--	8.0	pF
Input Capacitance	C _{ibo}	V _{EB} =-2.0Vdc, I _C =0, f=1.0MHz	--	--	30	pF
Turn-On Time	t _{on}	V _{CC} =-30Vdc, I _C =-150mAdc, I _{B1} =-15mAdc	--	--	45	μmhos
Delay Time	t _d		--	--	10	dB
Rise Time	t _r		--	--	40	nS
Storage Time	t _s	V _{CC} =-6.0Vdc, I _C =-150mAdc, I _{B1} = I _{B2} =-15mAdc	--	--	80	
Fall Time	t _f		--	--	30	nS
Turn-Off Time	t _{off}		--	--	100	

- FR-5=1.0x0.75x0.062in.
- Alumina=0.4x0.3x0.024in, 99.5% alumina.
- Pulse Width ≤300μS; Duty Cycle ≤2.0%.

Kingtronics® International CompanyWebsite: www.kingtronics.com Email: info@kingtronics.com Tel: (852) 8106 7033 Fax: (852) 8106 7099

Typical Performance Characteristics

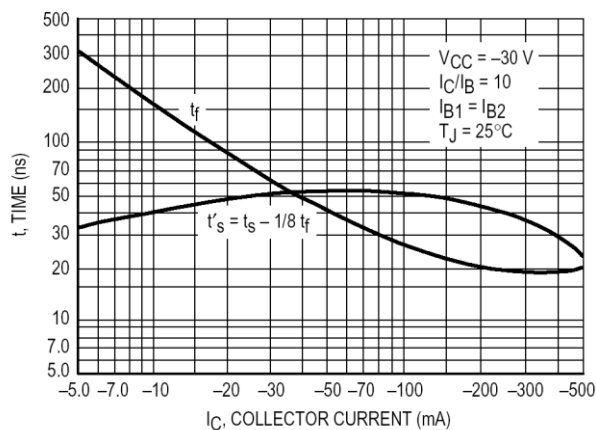
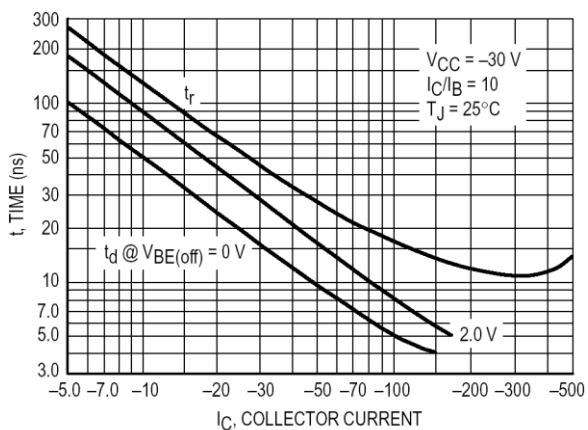
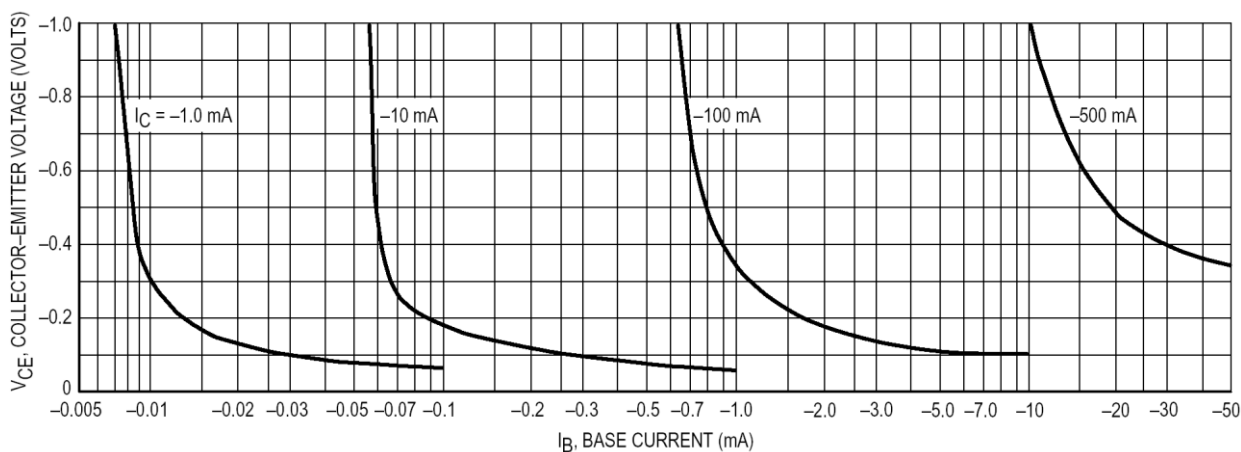
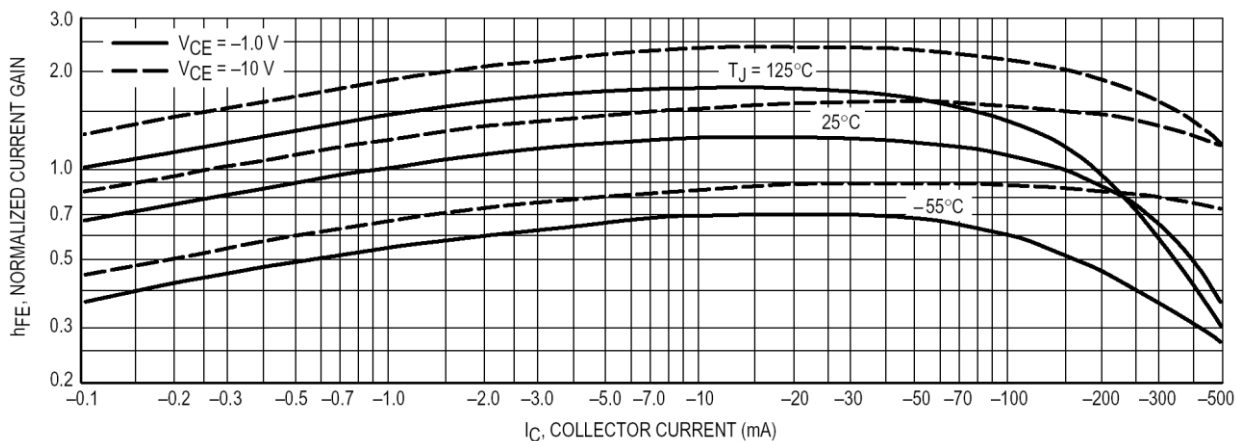

TYPICAL SMALL-SIGNAL CHARACTERISTICS

NOISE FIGURE

$V_{CE} = 10 \text{ Vdc}$, $T_A = 25^\circ\text{C}$

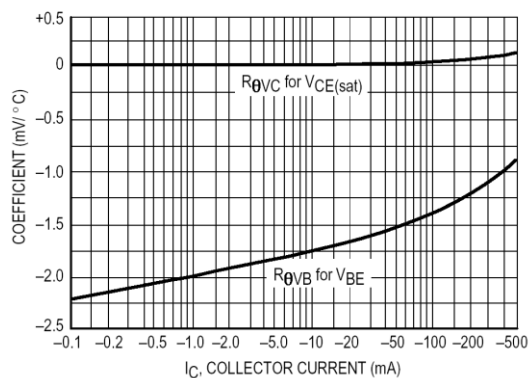
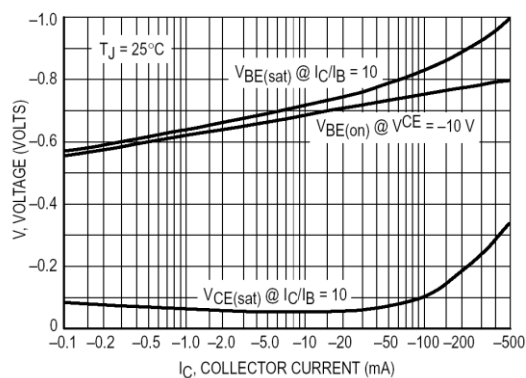
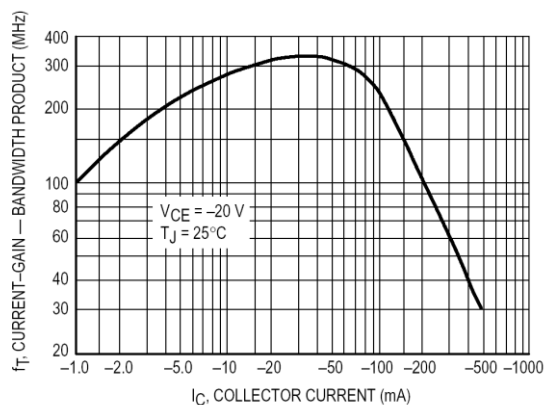
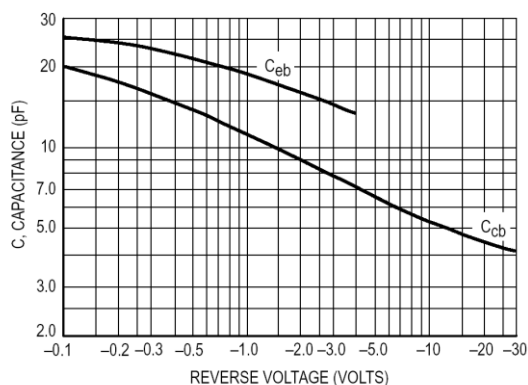
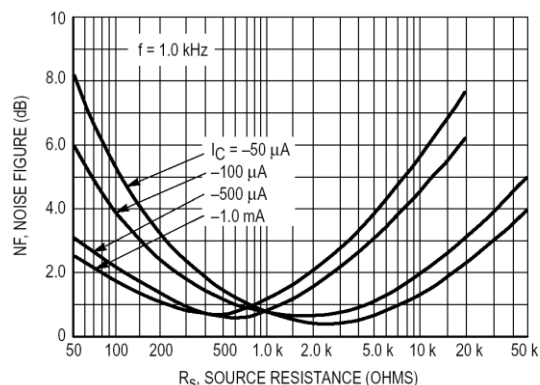
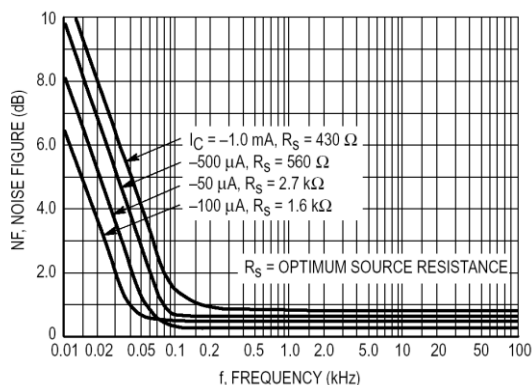

Note: Specifications are subject to change without notice.